

## Shower Rail System

# Silent Gliss® 1085

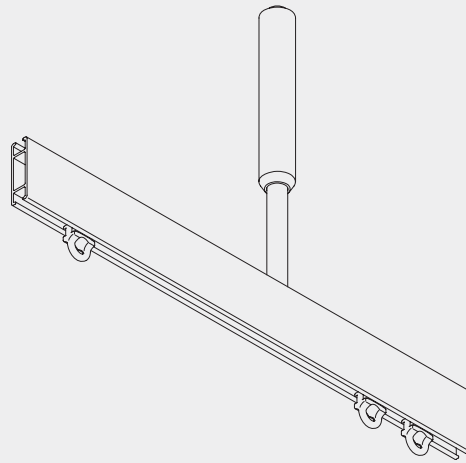

### Product Information

- For use as a shower rail only, not suitable for room divider/cubicle
- Attractive reversible rail with varied fixing possibilities
- For medium weight curtains
- Wide application for showers
- Available as a shower rail in kits
- Satin silver anodised finish only
- 4m lengths only



1085

[www.blindtrack.co.uk](http://www.blindtrack.co.uk)

Blindtrack  
Unit 23  
Orbital 25  
Dwight Road  
Watford  
WD18 9DA  
020 8421 6605  
[sales@blindtrack.co.uk](mailto:sales@blindtrack.co.uk)

## Profile, Bending and Specification Information

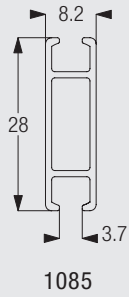

Standard radius 200mm.

The standard radius is recommended for optimal operation. The minimum possible radius is 150mm.

**Specification Guide - download from [www.silentgliss.co.uk](http://www.silentgliss.co.uk) (password required).**

Silent Gliss 1085 room divider system, anodised aluminium rail type 1085, secured to fittings detailed as follows. Allow for noggins in suspended ceiling / hollow partitions elsewhere in B of Q. Pre-forming bend in running length 90/135 degrees. Nylon glider/hook 3533C fitted to track at 10/ metre. Nylon wall support 3652 screwed/plugged and screwed to wall and fitted to track using endstop 3017. 3610S hanger rod system, anodised aluminium, drop ..... m once screwed through ceiling to noggin above and secured to track with 3699 insert.

## System Layout Options

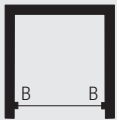
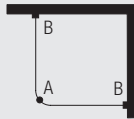
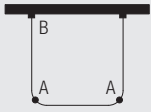

A: hanger rod 3610S  
B: wall support 3652



For straight applications hanger rods are not necessary except for extra strength on lengths above 6'/183cm. For pre-packed kits, refer to application chart.

1085

## Fitting Options

### Ceiling fix with hanger rod 3610S

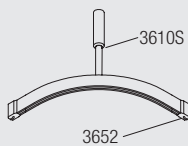
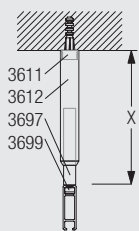

	X (m)
3610S	1.22

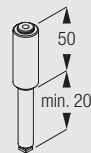

3610S  
Hanger rod assembly

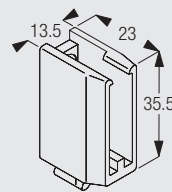

3652  
Wall support

## Wall fix with wall support 3652

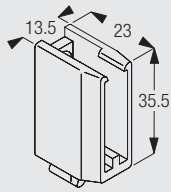
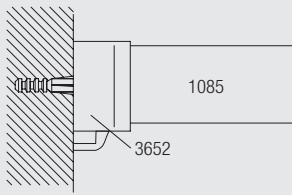





3652  
Wall support

### Standard Accessories

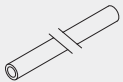
1085	Profile		3017	Endstop	
3652	Wall support		3533C	Glider with hook	

### Standard Accessories - Sets

3610S	Hanger rod assembly	3697	Rod	1	
		3698	Washer	1	
		3611	Stud	1	
		3612	Support with screw	1	
		3699	Track insert	1	

1085

### Optional Accessories

3070	Twist eye endstop		3071	Screw twist endstop	
3533	Glider		3534	Glider 3533 in strip form	
3570	Rotating glider		6146	Hook	

## Useful Information

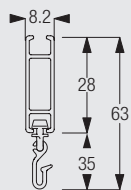

Diagram uses standard glider/hook combination 3533C. For glider 3570 the lower dimension will be 5.4mm.



1085



1085