

# SG 2740

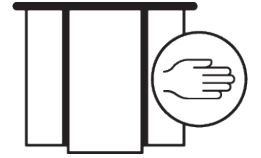

## WAVE PANEL

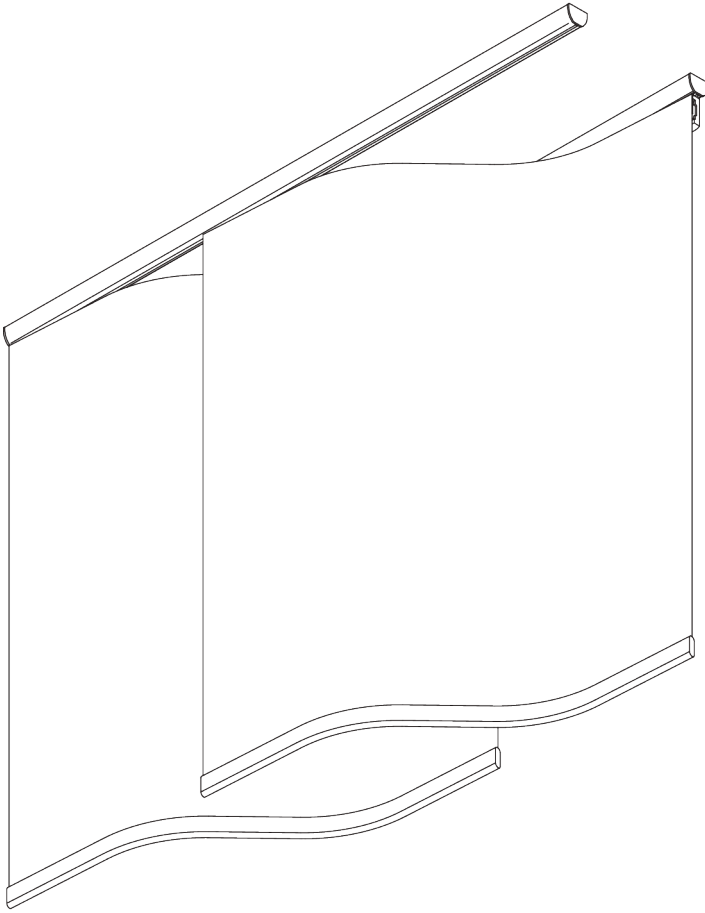

### PRODUCT INFORMATION

- **Operation:** hand
- **Range:** S - L
- **Fitting:** ceiling
- **Colours:** white RAL 9016; special colours or anodised aluminum possible
- **Fabrics:** refer to Silent Gliss fabric collection

#### **Features:**

- Wave-shaped panels
- Easy click-in carrier for fast installation
- Free floating or connected panels

# SYSTEM SPECIFICATIONS

## A. SYSTEM DIMENSIONS

Fixed panel width: 50 cm

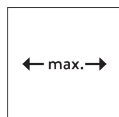

Panels free floating:  
unlimited

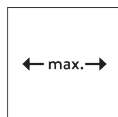

Panels connected (max.  
15 panels): 6.05 m

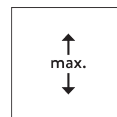

2.8 m



1 kg  
incl. bottom bar per panel

## Unconnected panels

System length in cm	Number of panels	Given overlapping in cm
100 - 136	3	18.1 - 0.1
137 - 181	4	14.9 - 0.2
182 - 226	5	11.2 - 0.2
227 - 272	6	9.1 - 0.1
273 - 317	7	7.5 - 0.1
318 - 363	8	6.4 - 0.0
364 - 408	9	5.6 - 0.1
409 - 453	10	5.0 - 0.1
454 - 499	11	4.5 - 0.0
500 - 544	12	4.1 - 0.1
545 - 590	13	3.8 - 0.0
591 - 635	14	3.4 - 0.0
636 - 680	15	3.2 - 0.1

## Connected panels

Max. 15 connected panels!

System length in cm	Number of panels	Width of all panels together (cm)
100 - 125	3	125
126 - 165	4	165
166 - 205	5	205
206 - 245	6	245
246 - 285	7	285
286 - 325	8	325
326 - 365	9	365
366 - 405	10	405
406 - 445	11	445
446 - 485	12	485
486 - 525	13	525
526 - 565	14	565
566 - 605	15	605

## **B. PROFILE**

### **Profile information**

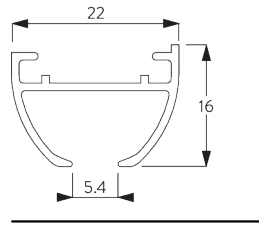

**SG 6010p**

Profile

## **C. HOW TO MEASURE**

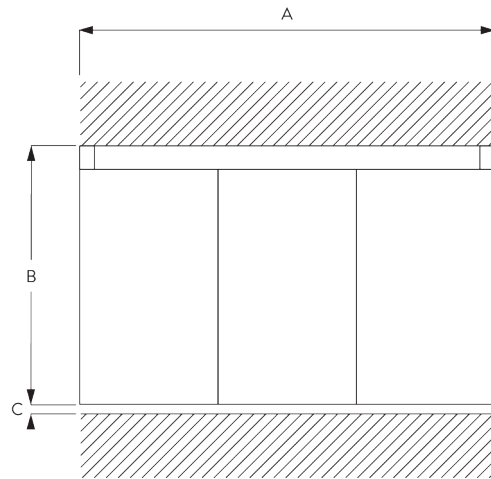

A: System width

B: System height

C: Distance between floor and fabric

## **Panel stacking**

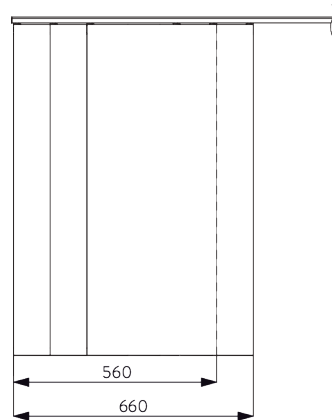

2 panels: 560 mm

3 panels: 660 mm

4 panels: 760 mm

5 panels: 860 mm

Each subsequent panel plus 100 mm

## Panel opening

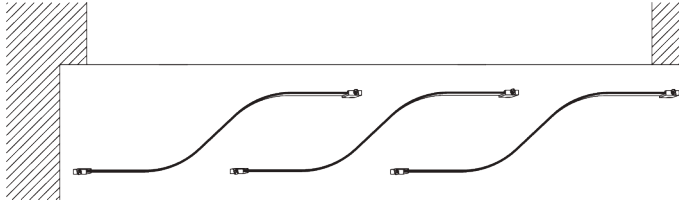

### Carrier A (standard)

Opening between panels is to the left of the room.

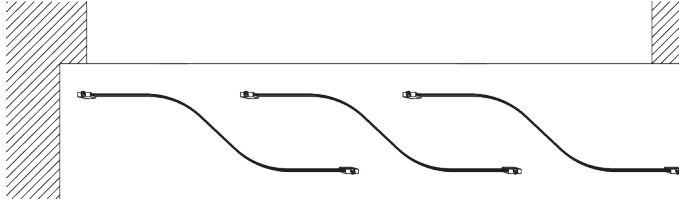

### Carrier B (option)

Opening between panels is to the right of the room.

## D. SPECIFICATION

### TEXT

**Silent Gliss SG 2740 Wave Panel System.** Supplied made to measure and complete comprising twin tracks SG 6010 with left carrier SG 11104 / right carrier SG 11109, click glider SG 11162 and bottom weight SG 11107. Fabric panels stack right hand / left hand. Hand operated with panels unconnected / connected. Ceiling fixed using clamps SG 3825. Fabric to be chosen from Silent Gliss fabric collection, Price Group 1 / 2 / 3.

# FITTING

## A. FITTING INFORMATION

For detailed fitting information, visit the [Silent Gliss website](#).

### Fixing points

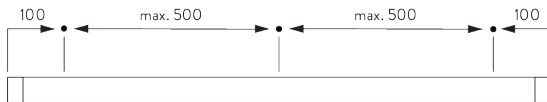

## B. CEILING FITTING

### Clamp SG 3825

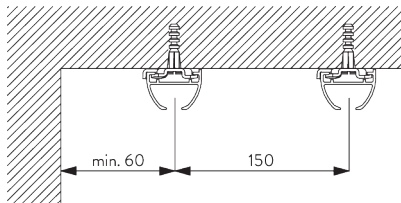

Distance between profiles: 15 cm

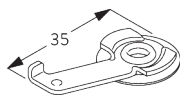

### SG 3825

Clamp

# GENERAL NOTES

## **Dimensions**

- Measurements are in mm except where indicated.
- Max. kg relates to fabric incl. accessories.
- Stack size depends on panel width.
- Recommended distance floor / fabric: 20 mm.
- In order to determine system height (B), the smallest room height must be taken into account.

## **Fitting**

- Installation by qualified fitter only.
- Number of brackets and fitting positions / fixing points vary depending on fitting surface, system weight, fabric make-up, screw / fixing type and obstacles.
- Qualified fitter must use appropriate screws / fixings for each situation.
- Profile lip if applicable to be installed to room side.
- Electrical installations must be carried out according to Silent Gliss wiring diagrams and conform to local regulations.
- Check space for cables and plugs!

## **Child Safety**

- All relevant Silent Gliss systems correspond to child safety EN 13120.
- All parties involved must comply with EN 13120.

# PARTS

## A. STANDARD PARTS



**SG 2539**

Tape



**SG 3825**

Clamp

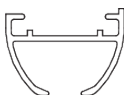

**SG 6010p**

Profile

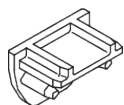

**SG 6018**

End cover



**SG 11104**

S-Carrier right Type A



**SG 11107**

Bottom weight



**SG 11161**

Glider cord 40 cm

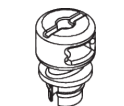

**SG 11162**

Click glider

## B. OPTIONAL PARTS

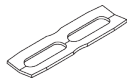

**SG 3802**

Connection bridge



**SG 11109**

S-Carrier left Type B



